

USER MANUAL for the SG-0005 SYSTEM

This product is meant to be used for electronic control of functions for spa baths. Please read all of the instructions carefully before enjoying the spa.

WARNING: Operating the system without water will cause severe damage. Contains electronic components, shock hazard. Does not contain user serviceable parts. Do not try to repair the control unit. Contact your dealer or service center for help. Follow all user instructions.

I. Installation

- 1) Open the door / cover according to the instructions and connect the power supply correctly.



Warning

- A. Installation is only to be made by qualified persons.
- B. Read the instructions carefully before beginning the installation.
- C. We are not responsible if the product does not work or is damaged when the instructions are not followed during installation.
- D. Ensure that the system is not damaged during transportation when it is unpacked.

Note!

- A. 1 x 16A (Read “Interlocked system between the heater and pumps”), 2 x 16A or 3 x 16 should be connected to the control system. Do not connect the power before the installation is complete.
- B. Install a maintenance switch close to the control system for use during maintenance work.
- C. An earth switch must be installed. Check that the earth switch works when the power is connected.

SG005 Sketch Of Linking Wires For The System

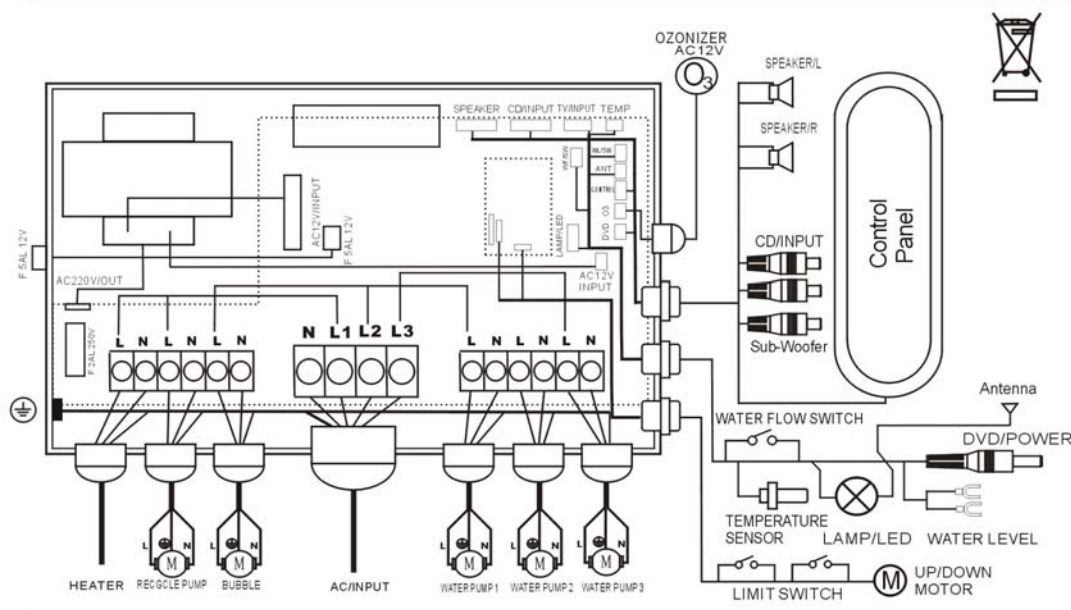

WIRING DIAGRAM 3-phase, 2-phase, 1-phase

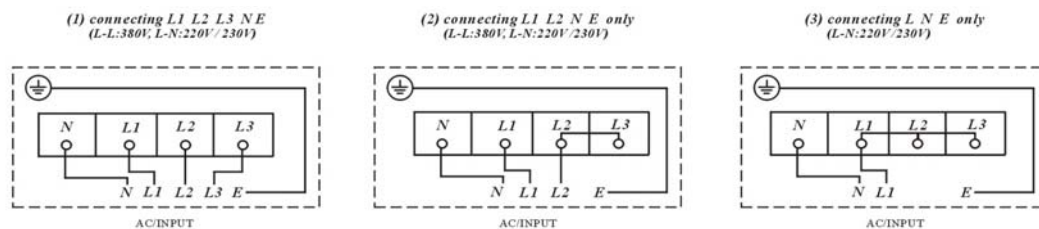

(Figure 1)



II. Operating instructions



(Fig 2)

- **ON/OFF key (power key):** Connect the power supply and press the ON/OFF key. All the control systems are now ready to run (indicator light is on), and the circulation and Ozone disinfection system will start working automatically (if the water temperature is not at the pre-set temperature, the heating system will start to work in 60 seconds). The panel will display the circulation and Ozone symbols (a symbol for the heating system will also be displayed on the panel if the heating system is working). The panel will also display the detected water temperature.
- **PUMP key:** press the (JET1) key. Its symbol  will now appear on the panel, signifying that massage pump 1 has been activated. JET1 and JET3 work in the same way and have their own symbols with numbers 2 and 3 on them. JET1, JET2 AND JET3 are accessories for some spa models.

NOTE: There are some air valves on the topside of spas near the seats. They are to control the strength of the hydro-massage in the respective seats.

- **BUBBLE key:** Press the  key. Its symbol will appear on the panel, meaning that the air massage system has started working.
- **O3 key (Ozone):** Pressing the O3 key will turn on or off the Ozone disinfection system (Ozone and circulation pump work automatically when activating the spa). **NOTE!** Ozone can be an accessory and another alternative is the UV-C ozone cleaner.
- **LAMP key:** When the control systems are ready to work, first press the  key. Its symbol will now appear on the panel, signifying that the underwater lights are on, the colour will change automatically; with a second press, the color will be fixed on a certain color; press for the third time to shut it off.

USER MANUAL for the SG-0005 SYSTEM

- **TEMP key (needs to be used together with ▲/▼ key):** Press the TEMP key, to display the water temperature set last time on the panel. This temperature will keep flashing: Press the “▲” key to adjust the temperature to the highest at 42° ; press the “▼” key to adjust the temperature to the lowest at 10° . The new temperature will be automatically stored and the display will then return to show the current water temperature after flashing for 3 seconds.
- **RADIO/AV key (Radio/DVD/Control and display of temperature):** When the control systems are ready to work, press the RADIO/AV key to activate the Radio function. The panel will now show the radio channel set last time (under Radio status, press +/- key to select pre-stored radio stations); a second press will activate the TV function (this function is optional). The panel will now show a TV symbol. A third press will activate the DVD function (this function is optional). The panel now shows a DVD symbol at the same time (Under DVD status, press the +/- key to adjust the volume of the DVD). Press for the fourth time to show the detected water temperature.
- **TUN/VOL key (needs to be used together with the +/- key):** Under Radio status, first press the TUN/VOL key. The panel will now show a 2-digit volume, pressing +/- will adjust the volume upwards or downwards (the panel will automatically show the radio frequency when you stop adjusting for 3 seconds). With a second press, the current frequency will flash. Pressing the +/- key will adjust the current frequency. This frequency will be stored automatically after flashing for 3 seconds. With a third press, the panel will show the radio channel. Press the +/- key to select pre-stored radio stations (the panel will automatically show the previous radio frequency after you stop adjusting for 3 seconds). With a long press for 5 seconds, the system will automatically search for radio frequencies again and store the searched frequencies at a different channel sequentially.
- **Heating system:** After the control systems are ready to work, the heater will start working 60 seconds after the circulation pump is activated, unless the temperature sensor detects that the set temperature is lower than the detected one. When the water temperature reaches a set temperature, the heater will stop working automatically. When the water temperature is under 2° of the preset one, the heater will reactivate. The

symbol for the heater is located above the circulation pump symbol , it appears as pulsing bubbles.

NOTE: The heater will not be activated if there is not enough water flow.

- **Interlocked system between the heater and pumps:** Pressing and holding the ON/OFF key again for 20 seconds will change the system between interlock mode or non-interlock mode (the indicator light on the ON/OFF key shows **RED** in interlock mode; while it shows **GREEN** in non-interlock mode). When in interlock mode, the heater will stop when you press any of the pump and bubble keys. This feature is meant to reduce the power needed for the spa so that it can match the power limit of some countries (1 x 16A). In non-interlocked mode, the heater will keep running when the other pumps are activated unless the water temperature reaches the set temperature.
- **Temperature sensor self-checking system:** If EO is displayed on the panel, then the temperature sensor is disconnected. In this situation check the wiring of the temperature sensor to see whether it is disconnected. If E1 is displayed on the panel, then the temperature sensor is short-circuited. In this situation the temperature sensor must be replaced. The heating system cannot be activated under the above two situations.
- **Water-lacking protection system for circulation pump and heater:** In daily usage, a blockage of the filtration medium (cartridge filter or filter bag) will eventually occur. A severe blockage will lead to an intermittent lack of water for the filtration pump. Air in the system often leads to the same problem. For instance, during startup if aeration has not been performed according to the instructions in the manual. When there is a lack of water, the filtration pump and heater will stop working automatically. At this moment, the symbol of the filtration pump  on the control panel will flash continuously, to remind the user that it is

USER MANUAL for the SG-0005 SYSTEM

time to clean or replace the filtration medium. After cleaning or replacing the filtration medium, press ON/OFF several times to expel the air inside the pipe until the filtration pump works normally.

- **Anti-freezing system:** After power on to enter standby status (the indicator light on ON/OFF key flashes), the anti-freezing system will be activated instantly. The circulation pump and heating system will automatically stop at the default temperature of above 10° . When the water temperature in the spa drops below 9° , the circulation pump, heater and air blower will work automatically, Jet1 (accessory) will automatically start to work in about 85 seconds; and it will stop after working about 85 seconds; then Jet2 (if equipped) will start to work for about 85 seconds and stop; finally Jet3 starts to work (if equipped) for about 85 seconds then stops. Pump1, Pump2 and Pump3 will continuously cycle among themselves. When the detected water temperature reaches 10° , all the pumps and heater will stop working. When this system is running, the screen background light is on. When the water temperature reaches 10° , the screen returns to the standby status.

Manual working mode: Turn on the spa, then press and hold the T/M key for 3 seconds to enter manual mode (the indicator light on the T/M key will show **GREEN when in manual mode**). In this mode, the circulation pump will run for 24 hours unless the spa is turned off.

Automatic working mode: Automatic working mode is on by default. Press and hold the T/A key for 3 seconds to switch over to automatic mode (The T/A button will be green). The circulation pump starts and runs for 1 hour (the display panel will cycle between "ON" and water temperature). After 1 hour the pump will stop for 3 hours (the display panel will cycle between "OFF" and water temperature). As long as the system is in automatic mode this filtration cycle will repeat indefinitely. Indicator light T1 (FILTER PROGRAM) shows green for 240 minutes. The keys 1, 2 and 3 (FILTER PROGRAM) are non-functional keys and only act as indicators.

NOTE:

- If the spa is in automatic working mode, please don't turn off the spa when not in use. Make sure the spa is always "on".
- When in automatic mode, the filtration pump will be controlled by temperature. If the water temperature is lower than the preset level, the filtration pump and heater will work until the water temperature has reached the preset level. Then, the filtration pump will return to work for 1 hour and stop for 3 hours repeatedly. When the automatic mode is not in use, the filtration pump won't be controlled by the temperature.
- Each time the spa is switched on, the system will go into the previously set mode. Press and hold the T/A or T/M key (the indicator will show **GREEN**) to switch between automatic mode and manual mode.

Summary T/A and T/M

If **T/A** is selected the filtration is handled automatically in cycles of "1 hour on, 3 hours off".

If **T/M** is selected the filtration pump (and thus the filtration) is on continuously, 24h per day without stopping in between.

If the preset temperature is higher than the actual water temperature then both the circulation pump and heater are activated until the water temperature reaches the chosen setting. The Ozone will automatically work together with the filtration pump and heater. This applies in both **T/A** and **T/M** modes.

FILTRATION PUMP - NOTE! If the hot tub is equipped with a massage pump it will be connected to "WATER PUMP 1". If there are two massage pumps the second is connected to "WATER PUMP 2". If an UV-C ozoner cleaner is installed, connect it so that it activates the same time as the circulatory pump.

BLOWER (BUBBLE) - ATTENTION! If the blower is used often and for prolonged periods of time, the blowers built in thermal protection might activate. The blower will stop and not restart until it's cooled down enough. You can speed up the

USER MANUAL for the SG-0005 SYSTEM

cooling by opening the service hatch(es). In doing so, please protect the equipment from potential freezing damage.